

# Device tag list

Heller\_Dynam\_Bed\_2L2C

device tag	number	denomination	Type	Manufacturer	Heller no.	device tag	number	denomination	Type	Manufacturer	Heller no.
+MU-115.11	1	plastic pipe	PA 10x1 1 820 712 105	AVENTICS	01.093306	+MU-215.3	1	pipe spiral	4x0,85-3000 PA12W 100034018	Stiefel	01.064865
+H1-200.1	1	lubrication unit	MFE5-KW6-S223+1FV 420V, 50Hz, 480V, 60Hz UL/CSA	SKF Lubrication Systems AG	01.111014	+MU-215.4	1	pipe spiral	4x0,85-3000 PA12W 100034018	Stiefel	01.064865
+H1-200.1-1	1	pump unit		SKF Lubrication Systems AG		+MU-215.5	1	pipe spiral	4x0,85-3000 PA12W 100034018	Stiefel	01.064865
+H1-200.1-2	1	filler plug	B7.06	SKF Lubrication Systems AG		+MU-215.6	1	pipe spiral	4x0,85-3000 PA12W 100034018	Stiefel	01.064865
+H1-200.1-3	1	float switch	WS35-S30+C51 (L=165mm)	SKF Lubrication Systems AG		+MU-215.10	1	pressure switch	PN7094 -1-10bar, G1/4	IFM Electronic	01.111724
+H1-200.1-4	1	pressure relief valve	WVN200-8B23	SKF Lubrication Systems AG	01.070541	+H1-215.21	1	hose line	S100-CR-CR-....	Hydrotechnik	
+H1-200.2	1	pressure filter	50LEN0040-H3XLA00-V5,0-M-R3-M-NB R928048246	Bosch Rexroth	01.107210	+H1-215.22	1	pressure switch	PN7092 0-100bar, G1/4	IFM Electronic	01.111726
+H1-200.2-1	1	filter element	2.0040H3XL-A00-0-M R928006645	Bosch Rexroth	01.107211	+MT-241.1	1	vane pump	FLM 12- 4041+1FV 254-280V, 440-480V, 60Hz UL	SKF Lubrication Systems AG	01.111855
+H1-200.2-2	1	clogging indicator	WE-2SP-M12x1 R928028410	Bosch Rexroth	01.106289	+MT-241.2	1	flow control switch	SBN232 NPT3/4, 0,38-25l/min	IFM Electronic	01.113743
+H1-200.3	1	check valve	RHD08LOMD-0,5-CF	Parker	01.067532	+H1-290.2	1	hose line	S100-CR-CR-....	Hydrotechnik	
+H1-200.4	1	plate	filter element	Heller Maschinenfabrik	10.500969	+H1-290.3	1	pressure switch	PN7092 0-100bar, G1/4	IFM Electronic	01.111726
+H1-206.1	1	lubrication unit	MFE5-KW6-S223+1FV 420V, 50Hz, 480V, 60Hz UL/CSA	SKF Lubrication Systems AG	01.111014	+TM-290.12	1	distributor strip	325-581	SKF Lubrication Systems AG	01.031954
+H1-206.1-1	1	pump unit		SKF Lubrication Systems AG		+TM-290.12-2	1	piston-type distributor	341-400-20000-00 0,03 cm3	SKF Lubrication Systems AG	01.005644
+H1-206.1-2	1	filler plug	B7.06	SKF Lubrication Systems AG		+TM-290.12-3	1	piston-type distributor	341-400-20000-00 0,03 cm3	SKF Lubrication Systems AG	01.005644
+H1-206.1-3	1	float switch	WS35-S30+C51 (L=165mm)	SKF Lubrication Systems AG		+TM-290.12-5	1	piston-type distributor	341-400-20000-00 0,03 cm3	SKF Lubrication Systems AG	01.005644
+H1-206.1-4	1	pressure relief valve	WVN200-8B23	SKF Lubrication Systems AG	01.070541	+MUT-290.21	1	plastic pipe	PA 8x1,25 WVN 715-RO 8x1,25	SKF Lubrication Systems AG	01.099359
+H1-206.2	1	pressure filter	50LEN0040-H3XLA00-V5,0-M-R3-M-NB R928048246	Bosch Rexroth	01.107210	+MUT-290.22	1	distributor strip	2-fach G1/4	Heller Maschinenfabrik	10.500823
+H1-206.2-1	1	filter element	2.0040H3XL-A00-0-M R928006645	Bosch Rexroth	01.107211	+MUT-290.22-1	1	piston-type distributor	341-400-50000-00 0,16 cm3	SKF Lubrication Systems AG	01.005645
+H1-206.2-2	1	clogging indicator	WE-2SP-M12x1 R928028410	Bosch Rexroth	01.106289	+MUT-290.22-2	1	piston-type distributor	341-400-50000-00 0,16 cm3	SKF Lubrication Systems AG	01.005645
+H1-206.3	1	check valve	RHD08LOMD-0,5-CF	Parker	01.067532	+MUT-290.22-3	1	piston-type distributor	341-400-50000-00 0,16 cm3	SKF Lubrication Systems AG	01.005645
+H1-206.4	1	plate	filter element	Heller Maschinenfabrik	10.500969	+MUT-290.22-4	1	piston-type distributor	341-400-50000-00 0,16 cm3	SKF Lubrication Systems AG	01.005645
+MU-210.1	1	reservoir		Heller Maschinenfabrik		+MUT-290.22-8	1	piston-type distributor	351-000-50000-00 0,2 cm3	SKF Lubrication Systems AG	01.068111
+MU-210.2	1	gear ring pump unit	143-012-127+564 280/480V, 60Hz, UL/CSA	SKF Lubrication Systems AG	01.101488	+MUT-290.23	1	plastic pipe	PA 8x1,25 WVN 715-RO 8x1,25	SKF Lubrication Systems AG	01.099359
+MU-210.3	1	ventilation filter	41 004 62 222	Mann + Hummel	01.061582	+MUT-290.24	1	distributor strip	4-fach G1/4	Heller Maschinenfabrik	10.500825
+MU-210.5	1	flow control switch	SBU323 G1/2 75l/min	IFM Electronic	01.111533	+MUT-290.25	1	plastic pipe	PA 8x1,25 WVN 715-RO 8x1,25	SKF Lubrication Systems AG	01.099359
+MU-210.6	1	hose line	DIN 20066-2SC16-NN-1000-P 462-10-1000	Parker	01.101113	+MUT-290.30	1	plastic pipe	PA 8x1,25 WVN 715-RO 8x1,25	SKF Lubrication Systems AG	01.099359
+MU-215.1	1	piston-type distributor	VOE-B/6/2-3/3/3/3/0/P	Eugen Woerner GmbH & Co.KG	01.085571	+MC-290.31	1	plastic pipe	PA 8x1,25 WVN 715-RO 8x1,25	SKF Lubrication Systems AG	01.099359
+MU-215.2	1	pipe spiral	4x0,85-3000 PA12W 100034018	Stiefel	01.064865	+MC-290.32	1	distributor strip	4-fach G1/4	Heller Maschinenfabrik	10.500825

Änderungen nur im CAD-Original!  
 Changes in CAD only!  
 Mudanças no original CAD somente!

© Copyright reserved - Gebr. HELLER Maschinenfabrik GmbH, D-72822 Nürtingen  
 Schutzvermerk nach DIN 34 beachten!  
 Attention! Observe DIN 34  
 Atenção! Observe DIN 34

ART DER AENDERUNG/REVISION/DESCRIÇÃO DE ALTERAÇÃO CAD-System				Index ZONE/ZONA DATUM/DATE NAME/NOME GEPR./CHECK./REG. BEARB./CHG./ALT. 04.04.2017 AHFE/ZAJ GEZ./DRAWN/DES. 04.04.2017 AHFE/ZAJ				PROJ./PROJ/ PROJ. 54807.00 M-NR/M-NO/ M-NO M54807 TYP/TYPE/ TIPO H 10000 MC - A-Axis WERKSTÜCK/ PART/PEÇA				<b>HELLER</b> BENENNUNG/NAME/DENOMINAÇÃO Device tag list lubrication				KUNDE/CUSTOMER/CLIENTE Paccar, Columbus USA INV-NR/INV-NO/NO-INV				PLAN/PLAN/PLANO project MP.05480700_F Machine =M54807 Document type &L lubrication diagram Mounting position Page name 0			
ePLAN 2.2.5																							

0.a

# Device tag list

Heller\_Dynam\_Bed\_2L2C

device tag	number	denomination	Type	Manufacturer	Heller no.
+MC-290.32-1	1	piston-type distributor	341-400-50000-00 0,16 cm3	SKF Lubrication Systems AG	01.005645
+MC-290.32-2	1	piston-type distributor	341-400-50000-00 0,16 cm3	SKF Lubrication Systems AG	01.005645
+MC-290.32-3	1	piston-type distributor	341-400-20000-00 0,03 cm3	SKF Lubrication Systems AG	01.005644
+MC-290.32-4	1	piston-type distributor	341-400-20000-00 0,03 cm3	SKF Lubrication Systems AG	01.005644
+MC-290.32-5	1	piston-type distributor	341-400-50000-00 0,16 cm3	SKF Lubrication Systems AG	01.005645
+MC-290.32-6	1	piston-type distributor	341-400-50000-00 0,16 cm3	SKF Lubrication Systems AG	01.005645
+MC-290.32-8	1	metering unit	352-020-K 0,2 cm3	SKF Lubrication Systems AG	01.008729
+MC-290.33	1	plastic pipe	PA 8x1,25 WVN 715-RO 8x1,25	SKF Lubrication Systems AG	01.099359
+MC-290.34	1	distributor strip	4-fach G1/4	Heller Maschinenfabrik	10.500825
+MC-290.35	1	plastic pipe	PA 8x1,25 WVN 715-RO 8x1,25	SKF Lubrication Systems AG	01.099359
+MC-290.40	1	plastic pipe	PA 8x1,25 WVN 715-RO 8x1,25	SKF Lubrication Systems AG	01.099359
+MT-290.41	1	plastic pipe	PA 8x1,25 WVN 715-RO 8x1,25	SKF Lubrication Systems AG	01.099359
+MT-290.42	1	distributor strip	2-fach G1/4	Heller Maschinenfabrik	10.500823
+MT-290.42-1	1	piston-type distributor	341-400-50000-00 0,16 cm3	SKF Lubrication Systems AG	01.005645
+MT-290.42-3	1	piston-type distributor	341-400-50000-00 0,16 cm3	SKF Lubrication Systems AG	01.005645
+MT-290.42-4	1	piston-type distributor	341-400-50000-00 0,16 cm3	SKF Lubrication Systems AG	01.005645
+MT-290.42-5	1	piston-type distributor	341-400-50000-00 0,16 cm3	SKF Lubrication Systems AG	01.005645
+MT-290.42-6	1	piston-type distributor	341-400-50000-00 0,16 cm3	SKF Lubrication Systems AG	01.005645
+MT-290.43	1	plastic pipe	PA 8x1,25 WVN 715-RO 8x1,25	SKF Lubrication Systems AG	01.099359
+MT-290.44	1	distributor strip	4-fach G1/4	Heller Maschinenfabrik	10.500825
+MT-290.45	1	plastic pipe	PA 8x1,25 WVN 715-RO 8x1,25	SKF Lubrication Systems AG	01.099359
+MT-290.50	1	plastic pipe	PA 8x1,25 WVN 715-RO 8x1,25	SKF Lubrication Systems AG	01.099359
+M-290.52	1	distributor strip	328-581	SKF Lubrication Systems AG	01.073896
+M-290.52-1	1	piston-type distributor	341-400-50000-00 0,16 cm3	SKF Lubrication Systems AG	01.005645
+M-290.52-5	1	piston-type distributor	341-400-20000-00 0,03 cm3	SKF Lubrication Systems AG	01.005644
+M-290.52-6	1	piston-type distributor	341-400-20000-00 0,03 cm3	SKF Lubrication Systems AG	01.005644
+M-290.52-7	1	piston-type distributor	341-400-20000-00 0,03 cm3	SKF Lubrication Systems AG	01.005644
+M-290.52-8	1	piston-type distributor	341-400-20000-00 0,03 cm3	SKF Lubrication Systems AG	01.005644

Änderungen nur im CAD-Original!  
 Changes in CAD only!  
 Mudanças no original CAD somente!

© Copyright reserved - Gebr. HELLER Maschinenfabrik GmbH, D-72822 Nürtingen  
 Schutzvermerk nach DIN 34, beachten!  
 Attention! Observe DIN 34  
 Atenção! Leia o DIN 34

ART DER AENDERUNG/REVISION/DESCRIÇÃO DE ALTERAÇÃO				Index	ZONE/ZONA	DATUM/DATE	NAME/NOME	PROJ./PROJ/ PROJ.	54807.00	<b>HELLER</b>	KUNDE/CUSTOMER/CLIENTE	PLAN/PLAN/PLANO	
CAD-System				URSPPR./ORIG.	GEPR./CHECK./REG.			M-NR/M-NO/ M-NO	M54807		Paccar, Columbus USA	project	MP.05480700_F
ePLAN 2.2.5				ERS./REP.	BEARB./CHG./ALT.	04.04.2017	AHFE/ZAJ	TYP/TYPER/ TIPO	H 10000 MC - A-Axis	Device tag list lubrication	INV-NR/INV-NO/NO-INV	Machine	=M54807
				ERS.D./REP.W.	GEZ./DRAWN/DES.	04.04.2017	AHFE/ZAJ	WERKSTÜCK/ PART/PEÇA			Document type	&L	lubrication diagram
											Mounting position		
											Page name	0.a	

# Lubrication points

Schmierformular\_Dyn

lubrication point		metering
LP1	machine bed tool changer	
LP5	machine bed Counter bearing, table	0,03 cm3
LP6	machine bed Table, spindle bearing	0,03 cm3
LP7	machine bed Counter bearing, column	0,03 cm3
LP8	machine bed Column, spindle bearing	0,03 cm3
LP101	Table spindle nut	0,16 cm3
LP203	column counter bearing	0,03 cm3
LP204	column spindle bearing	0,03 cm3
LP210	column spindle nut	0,2 cm3
LP308	Spindle unit spindle nut	0,2 cm3
LP331	spindle bearing 1	0,034 cm3
LP332	spindle bearing 2	0,034 cm3
LP333	spindle bearing 3	0,034 cm3
LP334	at the rear hollow shaft bearing 4	0,034 cm3
LP335	at the rear hollow shaft bearing 5	0,034 cm3
LP502	tool magazine chain	0,03 cm3
LP503	tool magazine chain	0,03 cm3
LP505	tool magazine guide frame down	0,03 cm3
total quantity per pulse		1,00 cm3

Änderungen nur im CAD-Original!  
 Changes in CAD only!  
 Mudanças no original CAD somente!

© Copyright reserved - Gebr. HELLER Maschinenfabrik GmbH, D-72622 Nürtingen  
 Schutzvermerk nach DIN 34 beachten!  
 Attention! Observe DIN 34  
 Atenção! Respeite DIN 34

← 0.a		2 →									
ART DER AENDERUNG/REVISION/DESCRIÇÃO DE ALTERAÇÃO		Index	ZONE/ZONA	DATUM/DATE	NAME/NOME	PROJ./PROJ/ PROJ.	54807.00	<b>HELLER</b>	KUNDE/CUSTOMER/CLIENTE	PLAN/PLAN/PLANO	
CAD-System		URSPR./ORIG.	GEPR./CHECK./REG.	BEARB./CHG./ALT.	AHFE/ZAJ	M-NR/M-NO/ M-NO	M54807		Paccar, Columbus USA	project	MP.05480700_F
ePLAN 2.2.5		ERS./REP.	GEZ./DRAWN/DES.	04.04.2017	AHFE/ZAJ	TYP/TYPE/ TIPO	H 10000 MC - A-Axis	lubricant table	INV-NR/INV-NO/NO-INV	Machine	=M54807
		ERS.D./REP.W.		04.04.2017	AHFE/ZAJ	WERKSTÜCK/ PART/PEÇA				Document type	&L lubrication diagram
									Mounting position		
									Page name	1	
										A3	

# Lubrication points

Schmierformular\_Dyn

lubrication point		metering
LP103	Table roller for runner block	0,16 cm3
LP104	Table roller for runner block	0,16 cm3
LP105	Table roller for runner block	0,16 cm3
LP106	Table roller for runner block	0,16 cm3
LP201	column roller for runner block	0,16 cm3
LP202	column roller for runner block	0,16 cm3
LP205	column roller for runner block	0,16 cm3
LP206	column roller for runner block	0,16 cm3
LP301	Spindle unit roller for runner block	0,16 cm3
LP302	Spindle unit roller for runner block	0,16 cm3
LP303	Spindle unit roller for runner block	0,16 cm3
LP304	Spindle unit roller for runner block	0,16 cm3
total quantity per pulse		1,92 cm3

Änderungen nur im CAD-Original!  
 Changes in CAD only!  
 Mudanças no original CAD somente!

© Copyright reserved - Gebr. HELLER Maschinenfabrik GmbH, D-72622 Nürtingen  
 Schutzvermerk nach DIN 34 beachten!  
 Attention! Observe DIN 34  
 Atenção! Atente DIN 34

← 1

+H1/1 →

ART DER AENDERUNG/REVISION/DESCRIÇÃO DE ALTERAÇÃO		Index	ZONE/ZONA	DATUM/DATE	NAME/NOME	PROJ./PROJ/ PROJ.	<div style="text-align: center; font-weight: bold; font-size: 1.2em;">HELLER</div>	KUNDE/CUSTOMER/CLIENTE	PLAN/PLAN/PLANO
CAD-System		URSPR./ORIG.	GEPR./CHECK./REG.			M-NR/M-NO/ M-NO		Paccar, Columbus USA	project
ePLAN 2.2.5		ERS./REP.	BEARB./CHG./ALT.	04.04.2017	AHFE/ZAJ	M54807	lubricant table 2	INV-NR/INV-NO/NO-INV	MP.05480700_F
		ERS.D./REP.W.	GEZ./DRAWN/DES.	04.04.2017	AHFE/ZAJ	H 10000 MC - A-Axis			Machine
						WERKSTÜCK/ PART/PEÇA		Document type	&L lubrication diagram
								Mounting position	
								Page name	2

Änderungen nur im CAD-Original!  
 Changes in CAD only!  
 Mudanças no original CAD somente!

© Copyright reserved - Gebr. HELLER Maschinenfabrik GmbH, D-72622 Nürtingen  
 Schutzvermerk nach DIN 34 beachten!  
 Attention! Observe DIN 34  
 Atenção! Atente DIN 34

Seamless precision steel pipe acc. to DIN ISO 10763 E235+N,  
 galvanised, chromium6-free  
 Parker screw connections, type EO-2 Plus, chromium6-free, male  
 stud connector with soft seal acc. to ISO 1179-2 type E  
 Parker 2SC-462 hose acc. to ISO 11237-1 EN 857, hose fitting  
 acc. to DIN ISO 12151-2, CA form  
 SKF WVN 715-RO PA plastic pipes, PA12 HIPHL and double  
 tapered ring duct unions

reservoir capacity 6 L  
 process medium lubrication oil ISO-L-CKC 68  
 acc. to ISO 6743-6 and ISO 3448

lubrication interval 10 min

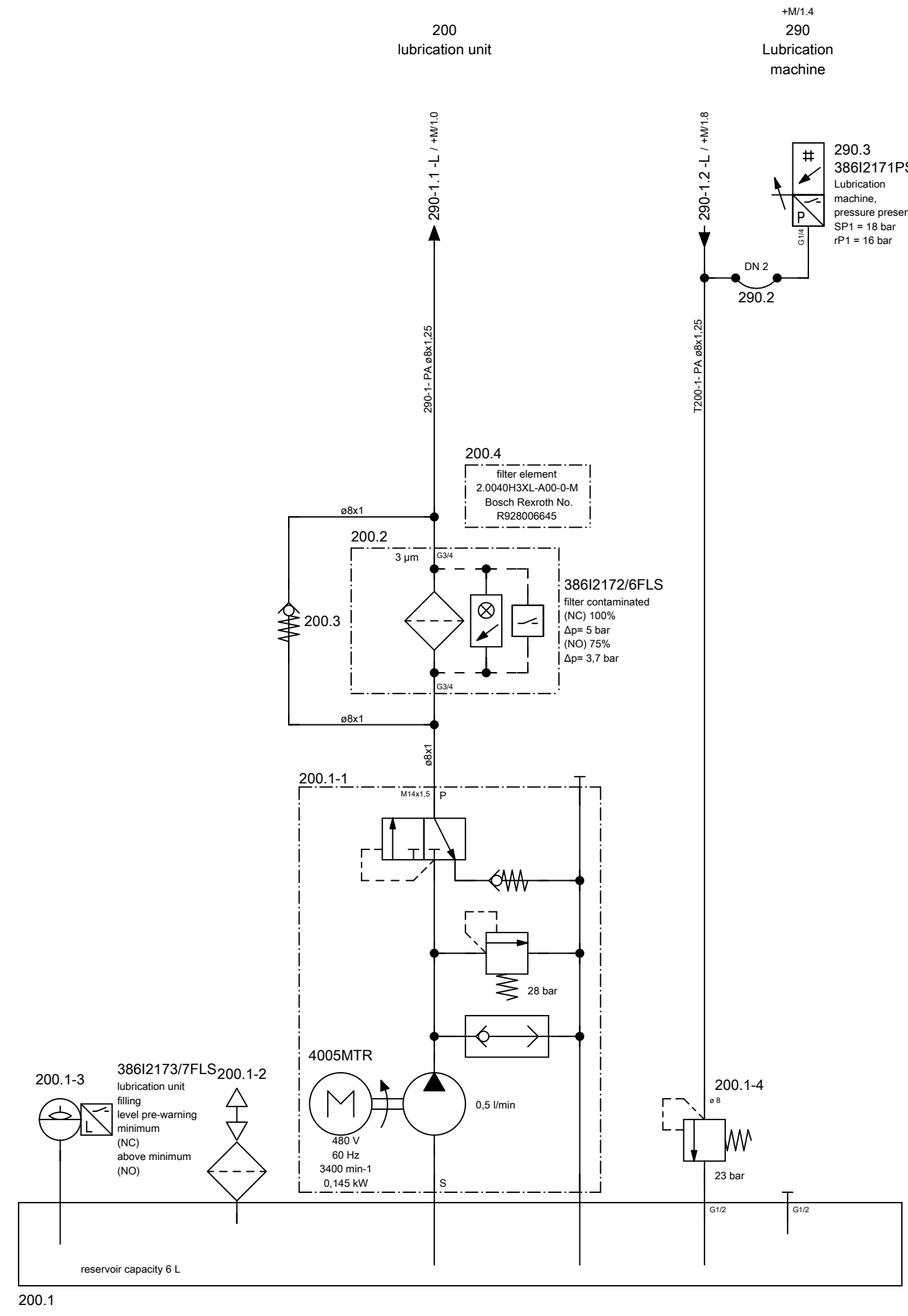

← +/2 2 →

ART DER AENDERUNG/REVISION/DESCRIÇÃO DE ALTERAÇÃO				Index	ZONE/ZONA	DATUM/DATE	NAME/NOME	PROJ./PROJ./PROJ.	54807.00	<b>HELLER</b>	KUNDE/CUSTOMER/CLIENTE	PLAN/PLAN/PLANO	
CAD-System				URSPPR./ORIG.	GEPR./CHECK./REG.			M-NR/M-NO/ M-NO	M54807		Paccar, Columbus USA	project	MP.05480700_F
ePLAN 2.2.5				ERS./REP.	BEARB./CHG./ALT.	04.04.2017	AHFE/ZAJ	TYP/TYPE/ TIPO	H 10000 MC - A-Axis	lubrication diagram	INV-NR/INV-NO/NO-INV	Machine	=M54807
				ERS.D./REP.W.	GEZ./DRAWN/DES.	15.03.2016	AHFE/HOP	WERKSTÜCK/ PART/PEÇA			13.503922	Document type	&L
											Mounting position	+H1	HELP1
											Page name	1	

Heller\_2L

Änderungen nur im CAD-Original!  
Changes in CAD only!  
Mudanças no original CAD somente!

© Copyright reserved - Gebr. HELLER Maschinenfabrik GmbH, D-72622 Nürtingen  
Schutzvermerk nach DIN 34 beachten!  
Attention! Observe DIN 34  
Atenção! Atenção DIN 34

Seamless precision steel pipe acc. to DIN ISO 10763 E235+N, galvanised, chromium6-free  
Parker screw connections, type EO-2 Plus, chromium6-free, male stud connector with soft seal acc. to ISO 1179-2 type E  
Parker 2SC-462 hose acc. to ISO 11237-1 EN 857, hose fitting acc. to DIN ISO 12151-2, CA form  
SKF WVN 715-RO PA plastic pipes, PA12 HIPHL and double tapered ring duct unions

reservoir capacity 6 L  
process medium lubrication oil ISO-L-CKC 68 acc. to ISO 6743-6 and ISO 3448

lubrication interval 10 min

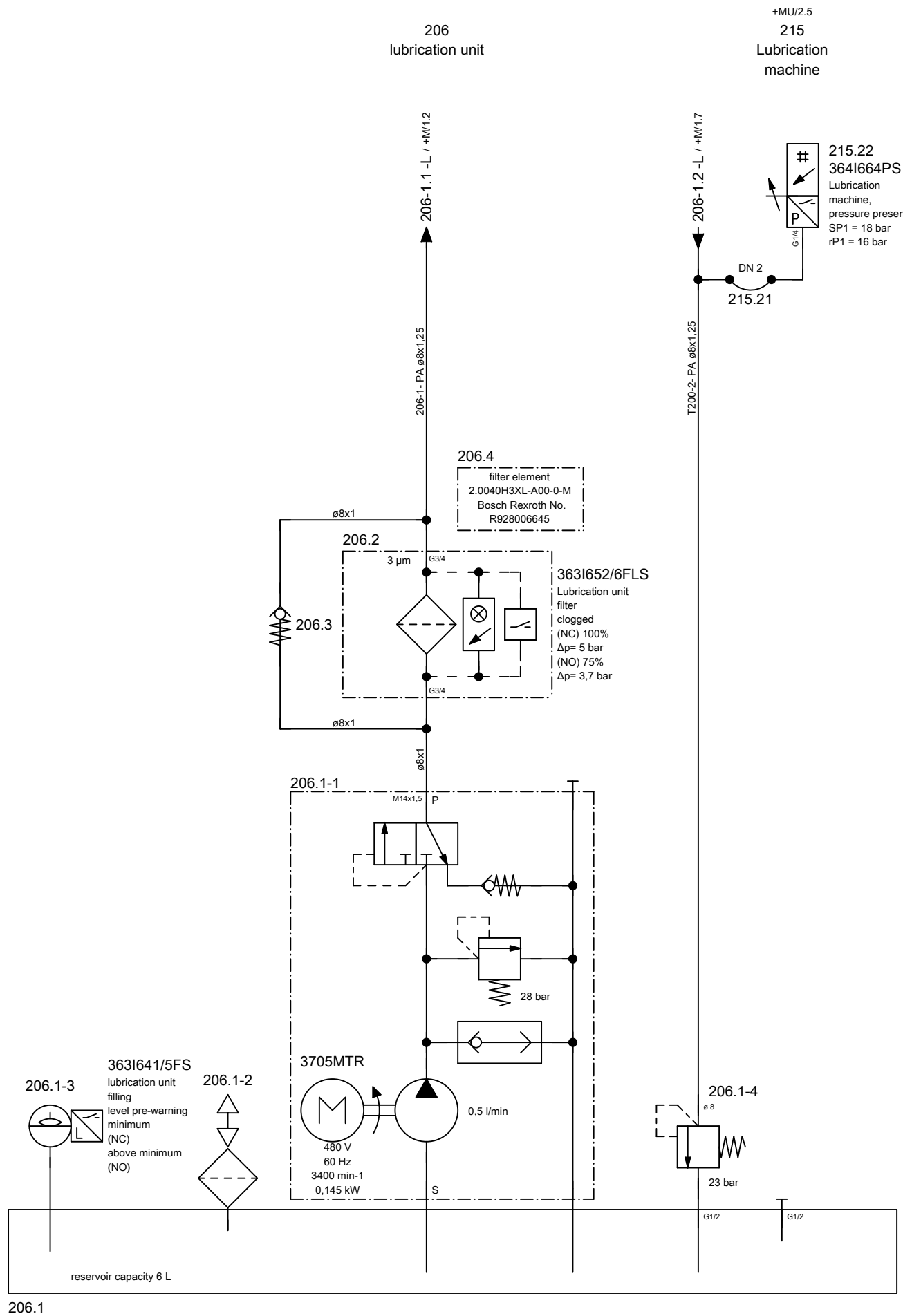

206.1

← 1

→ +MT/1

ART DER AENDERUNG/REVISION/DESCRIÇÃO DE ALTERAÇÃO				Index	ZONE/ZONA	DATUM/DATE	NAME/NOME	PROJ./PROJ./PROJ.	54807.00	<b>HELLER</b>	KUNDE/CUSTOMER/CLIENTE	PLAN/PLAN/PLANO	
CAD-System				URSPPR./ORIG.	GEPR./CHECK./REG.			M-NR/M-NO/ M-NO	M54807		Paccar, Columbus USA	project	MP.05480700_F
ePLAN 2.2.5				ERS./REP.	BEARB./CHG./ALT.	04.04.2017	AHFE/ZAJ	TYP/TYPE/ TIPO	H 10000 MC - A-Axis	lubrication diagram	INV-NR/INV-NO/NO-INV	Machine	=M54807
				ERS.D./REP.W.	GEZ./DRAWN/DES.	15.03.2016	AHFE/HOP	WERKSTÜCK/ PART/PEÇA			13.503922	Document type	&L lubrication diagram
												Mounting position	+H1 HELP1
												Page name	2

Heller\_2L

Änderungen nur im CAD-Original!  
 Changes in CAD only!  
 Mudanças no original CAD somente!

© Copyright reserved - Gebr. HELLER Maschinenfabrik GmbH, D-72822 Nürtingen  
 Schutzvermerk nach DIN 34 beachten!  
 Attention! Observe DIN 34  
 Atenção! Atente DIN 34

Seamless precision steel pipe acc. to DIN ISO 10763 E235+N,  
 galvanised, chromium6-free  
 Parker screw connections, type EO-2 Plus, chromium6-free, male  
 stud connector with soft seal acc. to ISO 1179-2 type E  
 Parker 2SC-462 hose acc. to ISO 11237-1 EN 857, hose fitting  
 acc. to DIN ISO 12151-2, CA form  
 SKF WVN 715-RO PA plastic pipes, PA12 HIPHL and double  
 tapered ring duct unions

**H 8000**  
 reservoir capacity 5,5 L  
 process medium lubrication oil SAE 80W  
 acc. to SAE J 306 and ISO 51512

**H 10000-14000**  
 reservoir capacity 17 L  
 process medium lubrication oil SAE 80W  
 acc. to SAE J 306 and ISO 51512

241  
rotary feed table

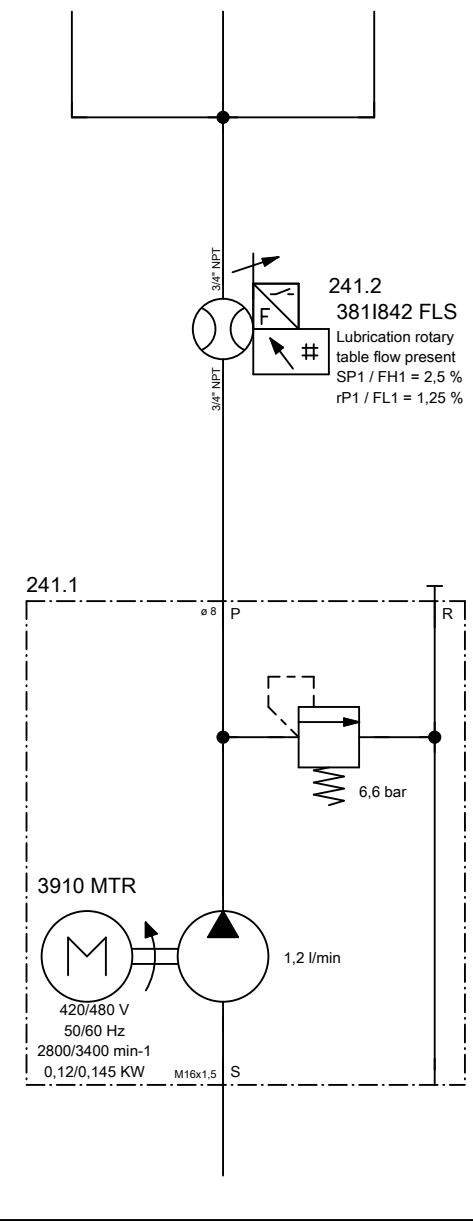
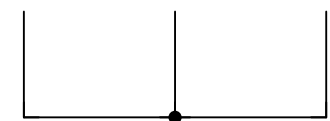
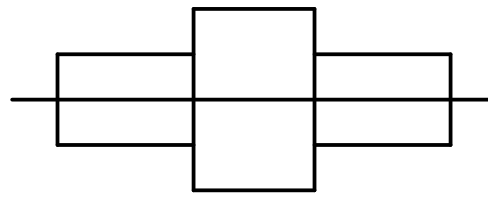

← +H1/2

+MU/1 →

ART DER AENDERUNG/REVISION/DESCRIÇÃO DE ALTERAÇÃO				Index	ZONE/ZONA	DATUM/DATE	NAME/NOME	PROJ./PROJ/ PROJ.	54807.00	<b>HELLER</b>	KUNDE/CUSTOMER/CLIENTE	PLAN/PLAN/PLANO	
CAD-System				URSPR./ORIG.	GEPR./CHECK./REG.			M-NR/M-NO/ M-NO	M54807		Paccar, Columbus USA	project	MP.05480700_F
ePLAN 2.2.5				ERS./REP.	BEARB./CHG./ALT.	04.04.2017	AHFE/ZAJ	TYP/TYPE/ TIPO	H 10000 MC - A-Axis	lubrication diagram	INV-NR/INV-NO/NO-INV	Machine	=M54807
				ERS.D./REP.W.	GEZ./DRAWN/DES.	15.03.2016	AHFE/HOP	WERKSTÜCK/ PART/PEÇA				Document type	&L lubrication diagram
											Mounting position	+MT table	
											Page name	1	

Heller\_2L

Änderungen nur im CAD-Original!  
Changes in CAD only!  
Mudanças no original CAD somente!

© Copyright reserved - Gebr. HELLER Maschinenfabrik GmbH, D-72822 Nürtingen  
Schutzvermerk nach DIN 34 beachten!  
Attention! Observe DIN 34  
Atenção! Atenção DIN 34

reservoir capacity 5 L  
process medium lubrication oil ISO-L-G 10  
acc. to ISO 6743-13 and ISO 3448

gear lubrication  
210

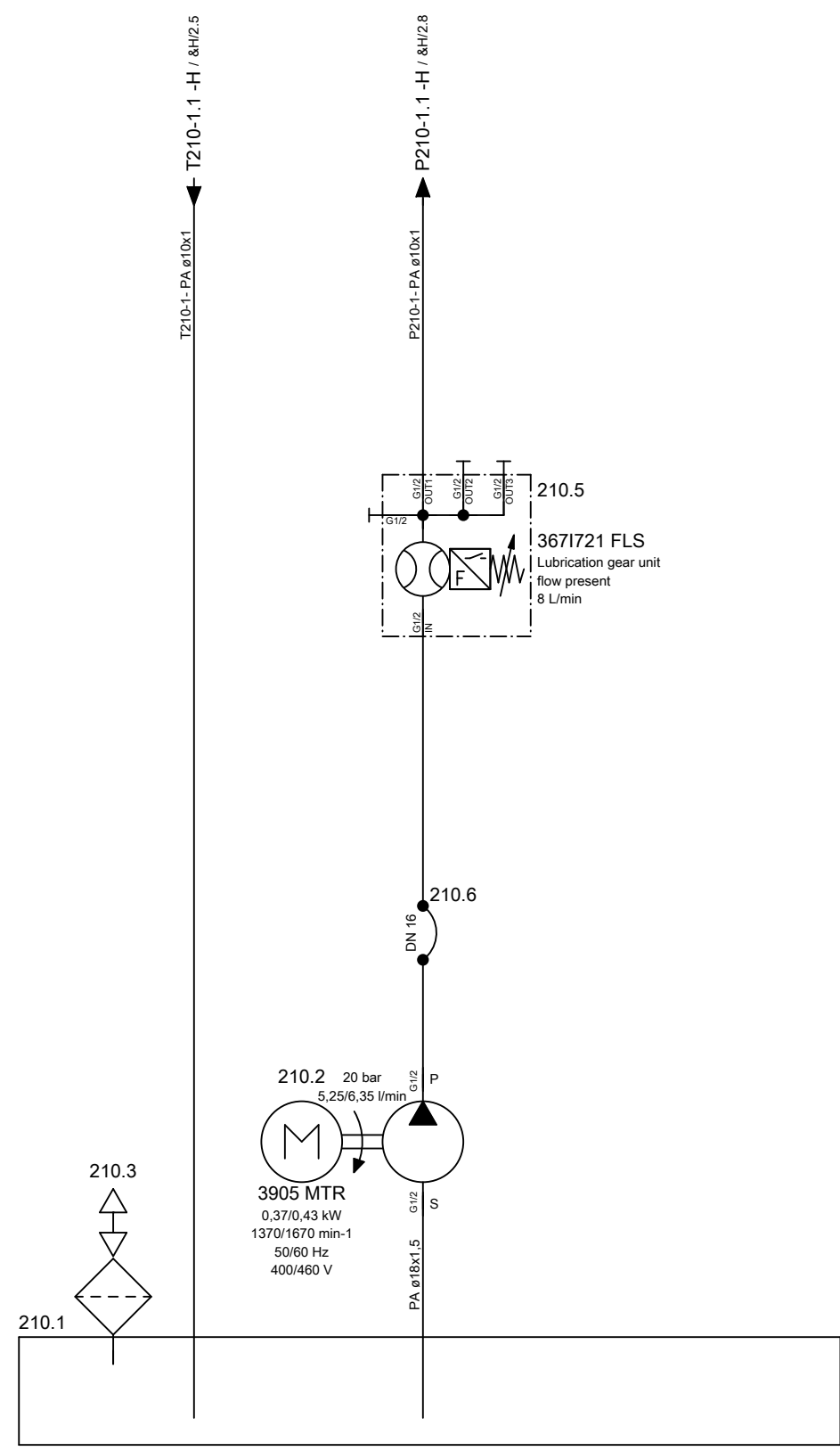

← +MT/1

2 →

ART DER AENDERUNG/REVISION/DESCRIÇÃO DE ALTERAÇÃO				Index	ZONE/ZONA	DATUM/DATE	NAME/NOME	PROJ./PROJ/ PROJ.	54807.00	<b>HELLER</b>	KUNDE/CUSTOMER/CLIENTE	PLAN/PLAN/PLANO			
CAD-System				URSPPR./ORIG.	GEPR./CHECK./REG.			M-NR./M-NO/ M-NO	M54807		Paccar, Columbus USA	project	MP.05480700_F		
ePLAN 2.2.5				ERS./REP.	BEARB./CHG./ALT.	04.04.2017	AHFE/ZAJ	TYP/TYPE/ TIPO	H 10000 MC - A-Axis	lubrication diagram	Machine	=M54807			
				ERS.D./REP.W.	GEZ./DRAWN/DES.	15.03.2016	AHFE/HOP	WERKSTÜCK/ PART/PEÇA			INV-NR./INV-NO/NO-INV	Document type	&L lubrication diagram		
											Mounting position	+MU unit	Page name	1	A3

Heller\_2L



Änderungen nur im CAD-Original!  
Changes in CAD only!  
Mudanças no original CAD somente!

© Copyright reserved - Gebr. HELLER Maschinenfabrik GmbH, D-72622 Nürtingen  
Schutzvermerk nach DIN 34 beachten!  
Attention! Observe DIN 34  
Atenção! Atenção DIN 34

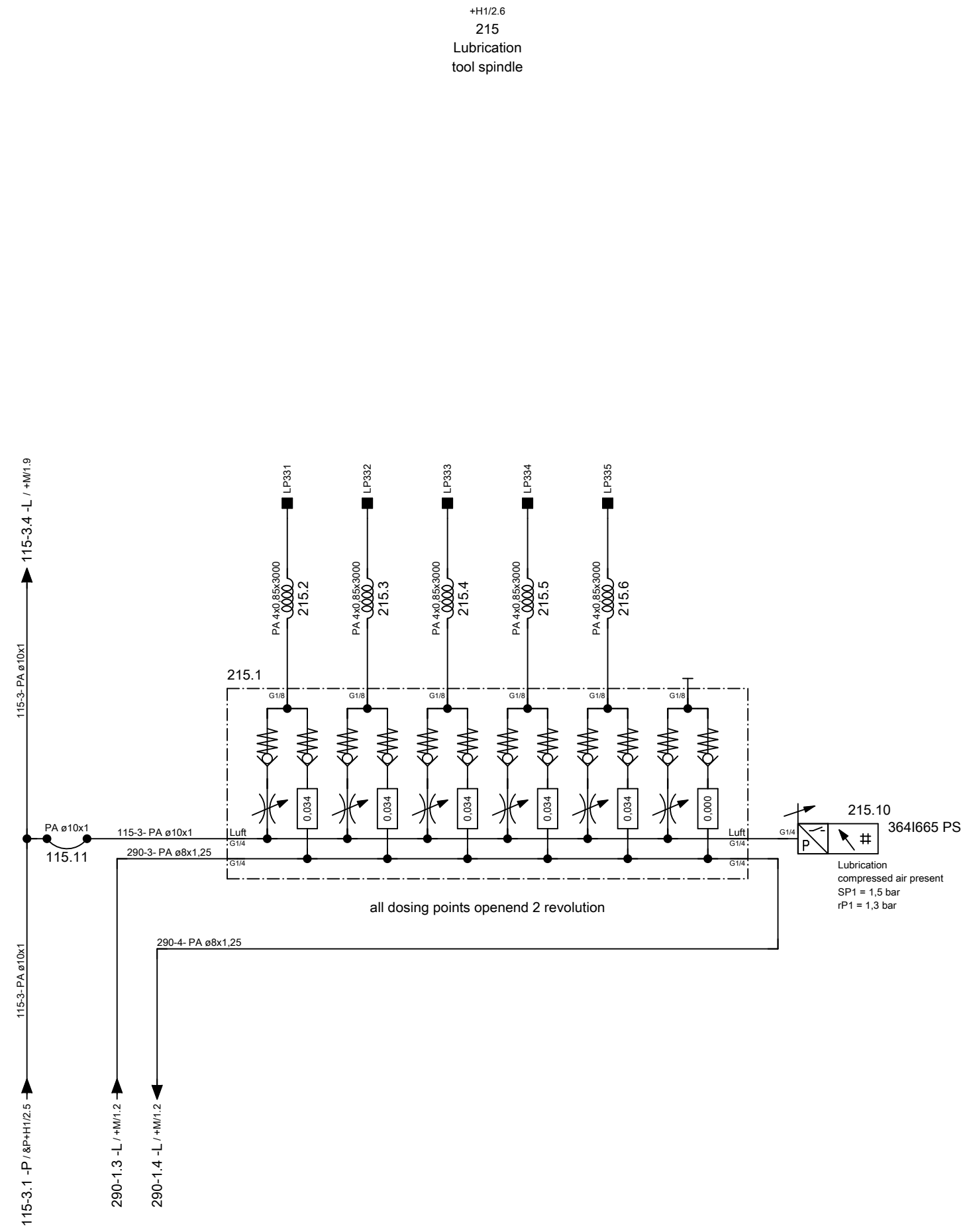

← 1

+M/1 →

ART DER AENDERUNG/REVISION/DESCRIÇÃO DE ALTERAÇÃO				Index	ZONE/ZONA	DATUM/DATE	NAME/NOME	PROJ./PROJ./PROJ.	54807.00	<b>HELLER</b>	KUNDE/CUSTOMER/CLIENTE	PLAN/PLAN/PLANO		
CAD-System				URSPPR./ORIG.	GEPR./CHECK./REG.			M-NR./M-NO/ M-NO	M54807		Paccar, Columbus USA	project	MP.05480700_F	
ePLAN 2.2.5				ERS./REP.	BEARB./CHG./ALT.	04.04.2017	AHFE/ZAJ	TYP./TYPE/ TIPO	H 10000 MC - A-Axis	lubrication diagram	INV-NR./INV-NO/NO-INV	Machine	=M54807	
				ERS.D./REP.W.	GEZ./DRAWN/DES.	15.03.2016	AHFE/HOP	WERKSTÜCK/ PART/PEÇA			Document type	&L	lubrication diagram	
										Mounting position	+MU	unit	Page name	2

Heller\_2L

A3

48 / 62

© Copyright reserved - Gebr. HELLER Maschinenfabrik GmbH, D-72622 Nürtingen  
 Schutzvermerk nach DIN 34 beachten!  
 Attention! Observe DIN 34  
 Atenção! Atente DIN 34

Änderungen nur im CAD-Original!  
 Changes in CAD only!  
 Mudanças no original CAD somente!

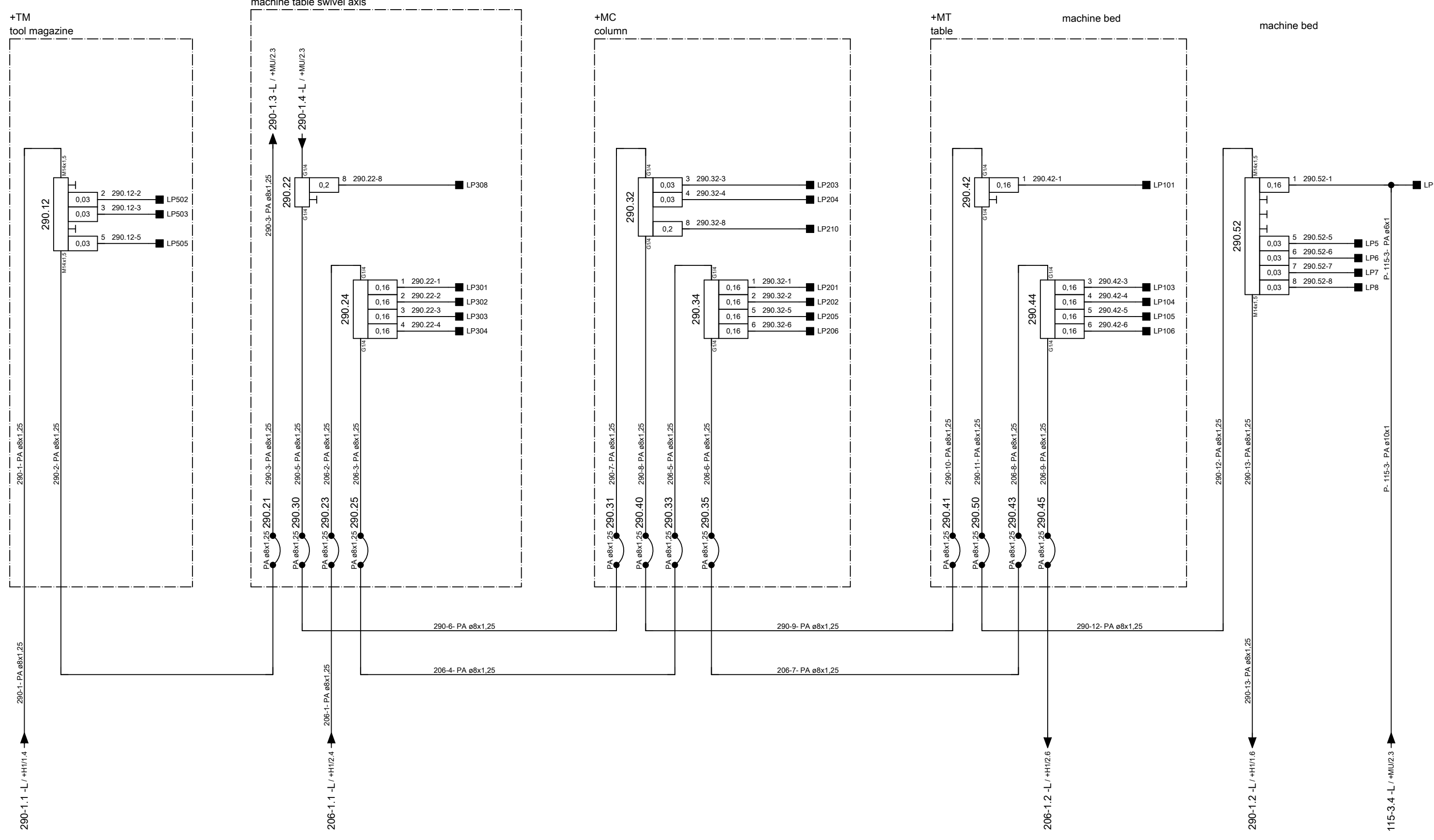

ART DER AENDERUNG/REVISION/DESCRIÇÃO DE ALTERAÇÃO				Index	ZONE/ZONA	DATUM/DATE	NAME/NOME	PROJ./PROJ./PROJ.	<b>HELLER</b>		KUNDE/CUSTOMER/CLIENTE	PLAN/PLAN/PLANO	
CAD-System				URSPR./ORIG.	GEPR./CHECK./REG.			M-NR/M-NO/ M-NO			Paccar, Columbus USA	project	MP.05480700_F
ePLAN 2.2.5				ERS./REP.	BEARB./CHG./ALT.	04.04.2017	AHFE/ZAJ	M54807	lubrication diagram		Machine	=M54807	
				ERS.D./REP.W.	GEZ./DRAWN/DES.	15.03.2016	AHFE/HOP	TYP/TYPE/ TIPO			H 10000 MC - A-Axis	INV-NR/INV-NO/NO-INV	Document type
								WERKSTÜCK/ PART/PEÇA			Mounting position	+M machine	
										Page name	1		